



charlotte console

DESIGN
PROSPERO RASULO

modello registrato
registered model

portata sul piano: 50 kg
portata sul ripiano: 6 kg
load capacity on the top: 50 kg
load capacity on each shelf: 6 kg

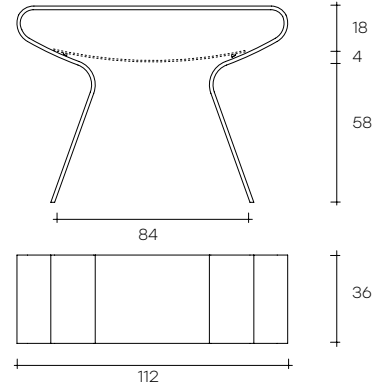

Consolle in vetro curvato da 15 mm.
Disponibile anche con ripiano
in vetro curvato acidato da 6 mm.

Console in 15 mm-thick curved glass.
Also available with 6 mm-thick
acid etched glass shelf.

dimensioni L, P, H
dimensions L, W, H
(cm)

COD./CODE

L

P/W

H

peso netto
net weight
(kg)

peso lordo
gross weight
(kg)

volume imballo
package volume
(m³)

Consolle.
Console.

1500

112

36

80

40

62

0,56

Piano di appoggio optional in vetro
curvato acidato da 6 mm.
Optional 6 mm-thick acid-etched
curved glass shelf.

1501

76

35,5

4

4

5

0,02

FINITURA (*)
FINISH (*)

SPESSORE
THICKNESS

Vetro extralight
Extralight glass

15 mm

(*) La finitura del ripiano segue quella della consolle.

(*) The finish of the shelf follows the console's one.